

AT100DY

Digital DC Multifunction Meter

User's Manual

V1.0



Hangzhou Antin Power Technology Co., Ltd

Declarations

All rights reserved. Without the written permission of the Company, no part of this manual may be extracted, copied or reproduced in any form, or transmitted, or all the consequences shall be borne by the violator.

The Company reserves all legal rights.

The Company reserves the right to make changes in the specifications of the products described in this manual without prior notice. Before ordering, please contact us or your local agent for the latest specifications of this product.

Content

Chapter 1 Product Overview	- 1 -
1.1 Product Introduction	- 1 -
1.2 Product Features	- 1 -
1.3 Product Parameter	- 2 -
Chapter 2 Technical Specifications	- 2 -
2.1 Technical parameters	- 2 -
2.2 Wiring Diagram	- 4 -
2.3 Shape/opening dimensions and installation drawings ..	- 5 -
Chapter 3 Operating Instructions	- 6 -
3.1 Key Description	- 6 -
3.2 Launch Interface	- 6 -
3.3 Parameter setting	- 7 -
3.3.1 Power parameter query	- 7 -
3.3.2 Other parameter enquiry (optional function)	- 8 -
3.3.3 Power parameter setting	- 8 -
3.3.4 Communication parameter setting	- 10 -

3.3.5 Power zero setting	- 12 -
3.3.6 Parameter setting for open volume	- 13 -
3.3.7 Transmission parameter setting	- 16 -
3.3.8 User Password Setting	- 18 -
Digital Tube English Correspondence Table	- 19 -
After-sales service	- 20 -

Chapter 1 Product Overview

1.1 Product Introduction

This series of multi-function power meter is an ideal equipment for power monitoring. The instrument has the function of measuring DC current, DC voltage, DC power, DC energy and so on at the same time. This series of multifunctional power meters can replace many traditional analogue or digital measuring instruments (e.g. DC ammeter, DC voltmeter, DC power meter, etc.), which can greatly reduce the system cost, facilitate the field wiring and improve the reliability of the system. Multi-function power monitor is equipped with a serial port, allowing connection to an open structure computer network; application of Modbus communication protocol, convenient for computer programming settings or reading data.

1.2 Product Features

- DC power parameter calculation
- Adopts modular design, flexible configuration of individual functions
- Voltage and current ratio adjustable
- Parameter setting password lock, power outage permanent preservation
- Support RS-485 communication, MODBUS-RTU protocol
- Adopts AC and DC dual-use power supply, high and low voltage isolation
- Digital tube display
- Simple and convenient installation and wiring

1.3 Product Parameter

Measurement and metrology	
Voltage	DC voltage
Current	DC current
Power	DC power
Electricity metering	
Electricity	DC current energy
Communication function	
Communication protocols	MODBUS-RTU
Communication method	RS485

Chapter 2 Technical Specifications

2.1 Technical parameters

Technical parameters		Norm
Applicable networks		DC 2-wire
Operating power	Voltage range	AC/DC85~265V; DC18V~72V(Optional)
	Power wastage	<2W
Accuracy level		0.5Class
Import	Voltage	Rating
		DC 100V、500V、1000V

		Power wastage	<0.4VA/Phase
		(electrical) impedance	$\geq 200k\Omega$
	Current	Rating	DC shunt DC75mV input
		Power wastage	<0.2VA/Phase
		(electrical) impedance	$\geq 0.1\Omega$
	Frequency		45Hz~65Hz
	Switching input		Dry contact input, optically isolated
Output	Switching output		Relay output; any power alarm can be set, default remote control
	Analogue output		0~20mA/0~5V(can be set arbitrarily)
	Digital communication interface		RS485/Modbus-RTU
	Pulse output		1~2 channels of electrical energy pulse
EMC 电磁兼容试验	Electrostatic discharge immunity test		GB/T 17626.2-2006: Test level 4, test voltage 8kV
	Radio Frequency Electromagnetic Field Immunity Test		GB/T 17626.3-2006: test level 3, test field strength 10V/m

Rapid transient pulse group test	GB/T 17626.4-2008: Test level 2, current voltage 1kV, other 500V
Surge (shock) immunity test	GB/T 17626.5-2008: Test level 4, test voltage 4kV
Conducted Nuisance Immunity Test for RF Field Induction	GB/T 17626.6-2008: Test level 3, test field strength 10V/m
Immunity tests for voltage dips, short-term interruptions and voltage variations	GB/T 17626.11-2008: Qualified current and voltage test error
Oscillatory wave immunity test	GB/T 17626.12-1998: Class B ITE test, qualified

2.2 Wiring Diagram

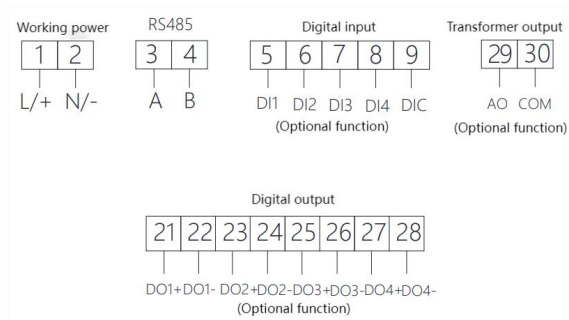

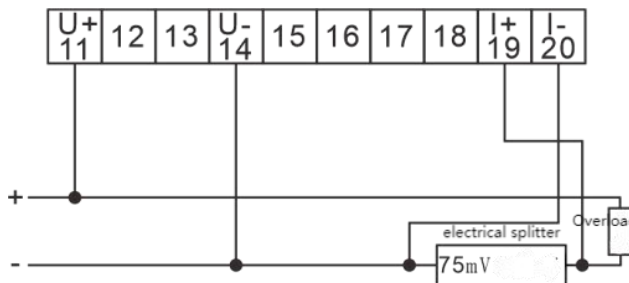



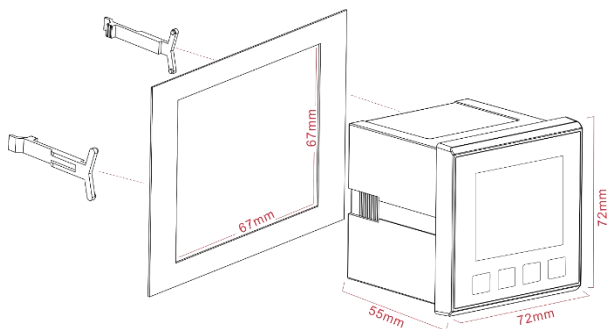

2.3 Shape/opening dimensions and installation drawings



Chapter 3 Operating Instructions

3.1 Key Description

 <p>Bs</p>	<p>Bs key:Return to the previous menu. It is used as a shift key to move the blinking bit during parameter setting, if it is in the last level menu.</p>
 <p>Up</p>	<p>Up key:View the previous screen display of the power, setup, select the previous option in the same level menu or type in the value when the value is incremented.</p>
 <p>Dn</p>	<p>Dn key:View the next screen display of the power, setup when you select the next option in the same level menu or key in the value of the value decreases.</p>
 <p>St</p>	<p>St key:Go to the next level menu. In the parameter setting, if in the last level menu, it will be used as save and return to the previous level menu; when the current menu is the password input menu, it will judge whether the password is correct or not, if it is correct, it will enter the next level menu, otherwise, it will return to the previous level menu.</p>



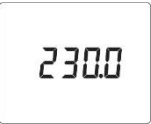

3.2 Launch Interface

	<p>The startup interface displays all the segment codes on the full screen, and the interface stays for 1s, which is used to detect whether the LCD screen can display normally.</p>
---	--

	After the startup interface completes the self-test, it enters the voltage display interface and acts as the main interface to display the instrument power parameters.
---	---



3.3 Parameter setting

3.3.1 Power parameter query

	In the initial interface state, through the "Up" and "Dn" keys, select the power parameter to be displayed, and the voltage interface is displayed by default.
	Press the "Dn" key to display the current screen.
	Press the "Dn" key to display the power.
	Press the "Dn" key to display the positive power.

	<p>Press the "Dn" key to display the reverse power.</p>
---	---

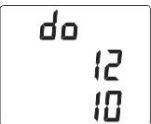

3.3.2 Other parameter enquiry (optional function)

	<p>Under the initial interface, press "St" and then press "Dn" continuously to find the other parameter query menu display interface (as shown in the left figure), enter this menu to query other extended function parameters.</p>
	<p>Press "St", the extended function parameter is displayed, the left figure shows the open quantity function information which indicates that there are 4 channels in total at present, and the 2nd channel open quantity is valid.</p>
	<p>Pressing "Dn", the left display shows the function information of the open quantity, which indicates that there are 2 open quantities at present, and the first open quantity is valid.</p>

3.3.3 Power parameter setting

Under the initial display interface, press "St" key continuously and "Dn" key continuously to find the menu item of user setting, as shown in the following figure, press "St" key to enter the user password input interface to complete the password input, increase or decrease the number through "Up" key and "Dn" key,

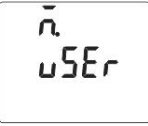

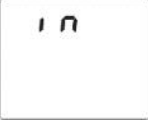
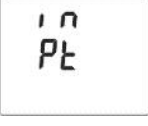



and shift the number blinking through "Bs" key. Press "St" key to enter the user password input interface to complete the password input, through the "Up" key and "Dn" key to increase or decrease the number, and through the "Bs" key to shift the number blinking, the factory initial password is The initial factory password is "0001".

	<p>In the initial interface, press the "St" key, and then press the "Dn" key continuously to find the menu item of user setting.</p>
	<p>Press "St" key, the password input interface will be displayed, enter the correct setup parameter to enter the setup parameter interface, the factory initial password is 0001.</p>
	<p>Enter the user parameter setting interface, press "Dn" key to find the power parameter setting menu item interface.</p>
	<p>Press the "St" key to display the electrical parameter setting option interface, use the "Up" and "Dn" keys to find the PT ratio setting menu item.</p>

	<p>Press the "St" key to display the PT ratio parameter setting interface, and set the desired PT ratio value (setting value: 1-5000) through the numeric increase/decrease key and "Bs" shift key.</p>
	<p>Press the "St" key to return to the electrical parameter setting option interface, and use the "Up" and "Dn" keys to find the CT ratio setting menu item.</p>
	<p>Press the "St" key to display the CT ratio parameter setting interface, and set the desired CT ratio value (setting value: 1-5000) through the numeric increase/decrease key and "Bs" shift key.</p>
	<p>After setting, press "St" to confirm the setting, press "Bs" continuously to select "y" blinking, and press "St". Press "Bs" key continuously to select "y" blinking, and press "St" key to confirm to save the parameter.</p>



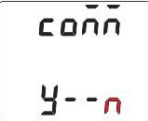

3.3.4 Communication parameter setting

	<p>Enter the user parameter setting interface, press the "Dn" key to find the communication parameter setting menu item interface.</p>
--	--

	<p>Press the "St" key to display the communication parameter option screen, use the "Up" and "Dn" keys to find the communication address setting menu item.</p>
	<p>Press the "St" key to display the communication address setting interface, and set the desired communication address value (setting value: 1-253) with the "Up" and "Dn" keys.</p>
	<p>Press the "St" key to return to the communication parameter option interface, and use the "Up" and "Dn" keys to find the communication baud rate menu item.</p>
	<p>Press the "St" key to display the baud rate setting interface, and set the desired communication baud rate through the "Up" and "Dn" keys (setting options: 4800/9600/9600). 19200).</p>
	<p>Press the "St" key to return to the communication parameter option interface, and use the "Up" and "Dn" keys to find the communication verification setting menu item.</p>
	<p>Press the "St" key to display the parity parameter setting interface, set the required parity bit (setting value: no/even/odd) by "Up" and "Dn" keys.</p>





	<p>After setting, press "St" to confirm the setting, press "Bs" continuously to select "y" blinking, and press "St". Press "Bs" key continuously to select "y" blinking, and press "St" key to confirm to save the parameter.</p>
---	---

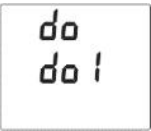
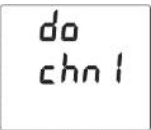

3.3.5 Power zero setting

	<p>Enter the user parameter setting interface, press the "Dn" key to find the system parameter setting menu item interface.</p>
	<p>Press the "St" key to display the system parameter setting interface, and use the "Up" and "Dn" keys to find the menu item of power clearing.</p>
	<p>Press "St" key to display the interface of power zero setting, switch "yes" by "Up" and "Dn" key. Select "yes" by pressing "Up" and "Dn".</p>
	<p>After setting, press "St" to confirm the setting, press "Bs" continuously to select "y" blinking, and press "St". Press "Bs" key continuously to select "y" blinking, and press "St" key to confirm to save the parameter.</p>

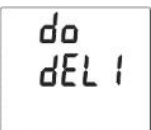
3.3.6 Parameter setting for open volume

do	Enter the user parameter setting interface, press the "Dn" key, and find the menu item of parameter setting interface.
do hch	Press the "St" key to display the open volume setting options screen, and use the "Up" and "Dn" keys to find the upper limit return parameter setting menu item.
do hch 0.90	Press "St" key to display the upper limit return parameter setting interface, use "Up" and "Dn" keys to set the upper limit return value (default is 0.9: i.e. the action value is 0.9% of the set value). 0.9 times of the set value).
do hcl	Press the "St" key to return to the output setting option interface, and use the "Up" and "Dn" keys to find the lower limit return parameter setting menu item.
do hcl 1.10	Press "St" key to display the lower limit return parameter setting interface, through the "Up" and "Dn" keys, set the lower limit return value (the default is 1.1: i.e. the action value is the setting value). The default is 1.1: i.e. the action value is 1.1 times of the setting value).

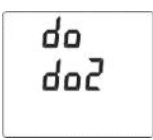
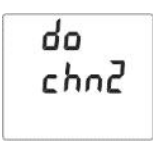
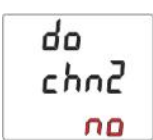

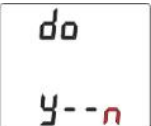

	<p>Press the "St" key to return to the output setting options screen, and use the "Up" and "Dn" keys to find the DO1 output setting menu item.</p>
	<p>Press the "St" key to display the DO1 output parameter setting interface, the default is DO1 output parameter channel selection menu item.</p>
	<p>Press the "St" key to display the DO1 parameter channel setting interface, and use the "Up" and "Dn" keys to set the desired channel parameters.</p>
	<p>Press the "St" key to return to the DO1 output parameter setting interface, and use the "Up" and "Dn" keys to find the DO1 parameter setting menu item.</p>
	<p>Press the "St" key to display the parameter setting option interface, use the "Up" and "Dn" keys to set the parameters of DO1 channel (setting value: change based on the default parameter value, such as). The upper limit value of voltage is 250V by default).</p>

	<p>Press "St" and "Bs" key to return to the output setting option screen, and then press "Up" and "Dn" key to select "Up" and "Dn". Up" and "Dn" keys to locate the DO2 output setting menu item.</p>
	<p>Press the "St" key to display the DO2 output parameter setting interface, the default is the DO2 output parameter channel selection menu item.</p>
	<p>Press the "St" key to display the DO1 parameter channel setting interface, and use the "Up" and "Dn" keys to set the desired channel parameters.</p>
	<p>Press the "St" key to return to the DO2 output parameter setting interface, and use the "Up" and "Dn" keys to find the DO2 parameter setting menu item.</p>
	<p>Press the "St" key to display the parameter setting option interface, use the "Up" and "Dn" keys to set the parameters of DO2 channel (setting value: change based on the default parameter value, such as). The lower voltage limit value is 150V by default).</p>

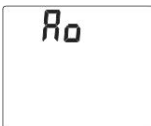
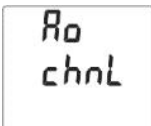
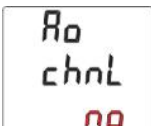
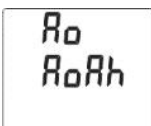
	<p>After setting, press "St" to confirm the setting, press "Bs" continuously to select "y" blinking, and press "St". Press "Bs" key continuously to select "y" blinking, and press "St" key to confirm to save the parameter.</p>
---	---

3.3.7 Transmission parameter setting

	<p>Enter the user parameter setting interface, press the "Dn" key to find the menu item of parameter setting interface of variable transmission.</p>
	<p>Press the "St" key to display the variable output setting option interface, use the "Up" and "Dn" keys to find the variable output channel setting menu item.</p>
	<p>Press the "St" key to display the channel setting interface of the transmission parameters, and set the required channel parameters by using the "Up" and "Dn" keys.</p>
	<p>Press the "St" key to display the variable output setting option interface, and use the "Up" and "Dn" keys to find the variable output upper limit setting menu item.</p>

	<p>Press "St" key to display the upper limit setting interface of variable output, set the required upper limit parameter through "Up" and "Dn" keys (setting value: 4-20; default 20).</p>
	<p>Press the "St" key to return to the variable output setting option interface, and use the "Up" and "Dn" keys to find the variable output lower limit setting menu item.</p>
	<p>Press "St" key to display the lower limit setting interface of variable output, set the required lower limit value parameter by "Up" and "Dn" keys (setting value: 4-20; default 4). Setting value: 4-20; default 4).</p>
	<p>Press the "St" key to return to the variable setting option interface, and use the "Up" and "Dn" keys to find the variable channel parameter upper limit setting menu item.</p>
	<p>Press "St" key to display the upper limit setting interface of variable transmission parameter, through "Up" and "Dn" keys, set the required parameter (setting value: change based on the default parameter value, such as variable). (Setting value: change based on the default parameter value, for example, the default value of the upper limit of variable transmission is 230V).</p>

	<p>Press the "St" key to return to the variable setting option interface, and use the "Up" and "Dn" keys to find the lower limit setting menu item of the variable channel parameters.</p>
	<p>Press "St" key to display the lower limit setting interface of variable transmission parameter, through "Up" and "Dn" keys, set the required parameter (setting value: change based on the default parameter value, such as variable). (Setting value: change based on the default parameter value, e.g. the default value of lower limit of variable transmission is 0.0V).</p>
	<p>After setting, press "St" to confirm the setting, press "Bs" continuously to select "y" blinking, and press "St". Press "Bs" key continuously to select "y" blinking, and press "St" key to confirm to save the parameter.</p>

3.3.8 User Password Setting

	<p>Enter the user parameter setting interface, press the "Dn" key to find the system parameter setting menu item interface.</p>
--	---

	<p>Press the "St" key to display the system parameter setting interface, and use the "Up" and "Dn" keys to find the user password menu item.</p>
	<p>Press the "St" key to display the user password setting interface, and use the "Up" and "Dn" keys to set the desired new user password.</p>
	<p>After setting, press "St" to confirm the setting, press "Bs" continuously to select "y" blinking, and press "St". Press "Bs" key continuously to select "y" blinking, and press "St" key to confirm to save the parameter.</p>

Digital Tube English Correspondence Table

1	2	3	4	5	6	7	8	9	0	A	B
1	2	3	4	5	6	7	8	9	0	A	B
C	D	E	F	G	H	I	J	K	L	M	N
C	d	E	F	G	H	,	J	L	ñ	n	
O	P	Q	R	S	T	U	V	W	X	Y	Z
o	P	q	r	s	t	u	v	w	x	y	z

After-sales service

1. If the user does not understand the description in the manual during installation and commissioning, please contact the aftersales team.
2. The company's technology is ready to answer product-related questions.
3. The problems arising in the use of the product will be replied within one working day.
4. Our company has a one-year free warranty for the above products from the date of sale.

Technical descriptions are subject to change without notice

Hangzhou Antin Power Technology Co., Ltd.

R&D headquarters: 8th floor, Lufang Science and Technology Innovation Building, Xihu District, Hangzhou City, Zhejiang Province

Intelligent manufacturing base: 4th Floor, Building 3, Block C, Qinglan Science and Technology Innovation Park, Xihu District, Hangzhou City, Zhejiang Province

Email: sales@china-antin.com

Website: <http://www.china-antin.com>